



SCC1000 Hydraulic Crawler Crane



SHANGHAI SANY SCIENCE & TECHNOLOGY CO.,LTD.

Contents

Upperworks	1
Lowerworks	2
Operation Device	2
Safety Device	3
Dimension	4
Transportation Dimension of Main Parts	5
Self and Jib Assembly and Disassembly	9
Main Boom Combination	10
Main Boom Range Diagram	11
Main Boom Load Chart	12
Jib Range Diagram	13
Jib Combination	14
Jib Load Chart	15



SCC1000 Hydraulic Crawler Crane



Detail Introduction

Upperworks

Engine

The imported Cummins 6CTAA-250 inline six-cylinder, air cooling, four stroke diesel engine with a rated power of 186kW and a rated speed of 2200rpm. The maximum output torque is 1219N·m and the rotation speed at maximum output torque is 1300rpm.

This engine is equipped with a diesel oil tank with a capacity of 400L.

Control

Fully-hydraulic control system allows precise control over main and auxiliary winch, brake, luffing, swinging and traveling. Control process is smooth.

Hydraulic System

Hydraulic system consists of three parts: main circuit, control circuit and auxiliary circuit. Most hydraulic elements are made by Bosch REXROTH.

The swing system is of closed circuit with quick operation respond, smooth action, little thermal value and long life span.

The main pump is of variable displacement dual pump with power control, forming an open circuit with system pressure 30MPa.

Main and auxiliary hoisting device

Bosch REXROTH variable displacement hydraulic motor drives planet gear speed reducer to control the hoisting and lowering of main and auxiliary winch devices, and the variable displacement hydraulic motor can adjust displacement automatically according to the load to achieve the maximum winch speed.

Main and auxiliary winch drum

Diameter of drum: 560mm

outermost rope speed: 0-110m/min

Rated line-pull: 9 t

Wire rope

Specification: 24Flexpack/34(W) × k7

Diameter: 24mm

Length: 290m (main winch) 210m (auxiliary winch)

Fracture tensile force: 53.1t

Luffing device

Luffing winch drum is equipped with ratchet pallet locking gear to ensure the safety of boom under shut-down conditions.

Luffing winch drum

Diameter of winch drum: 420mm

Rise and fall time of luffing: 70s(30° ~ 80°)

Rated line-pull: 7 t

Wire rope

Specification: 20NAT6 × 29Fi-HWR1910ZS

Diameter: 20mm

Length: 240m

Fracture tensile force: 33.7t

Swing Gear

Swing gear: driven by swing motor, allowing 360° revolution.

Swing brake: spring loaded, pressure released and band type spring brake.

Swing lock: locking gear is provided to protect the upperworks revolution from the impact during hoisting traveling or transportation.

Rotating bed turntable: three-row-roller bearing. Type: 131.32.2000; Diameter of roller: $\varnothing 32$; Roller track: $\varnothing 2000$.

Speed of swing: 1.9r/min (idling)

Swing Table

Swing table consists of left and right traveling table and main platform. The entire swing table is connected with crawler traveling mechanism through rotating bed turntable. Main hoisting mechanism, auxiliary hoisting mechanism, luffing mechanism, hydraulic system, power system and cab are all mounted on the swing table. A-frame, operation equipment and counterweight are connected with different parts of the swing table respectively.

A-frame

Three-section telescopic design. The A-frame stretches out during operation while retract back during transportation so as to reduce the transportation width.

Counterweight

Each block of Counterweight is 6t and there are 7 in all the together weight is 42t. The Counterweight can achieve fully self-loading and unloading to facilitate transportation.

Cover

Left cover: toolbox is below the first step in the front part. Armrest for getting on is equipped in the front part, and the water tank inlet is on the top. Five access doors, which are equipped with silencing sponge, are provided in outside of the cover; the shutter is mounted inside.

Right cover: there is an access door with built-in silencing sponge.



SCC1000 Hydraulic Crawler Crane



Driver's Cab

The novelty pattern sliding door of cab allows easy and safe opening and closing of door and window; the large window, together with head light and rearview mirror, permits wider visual field; the perfect sealing and dust-proof and shock absorption can reduce the noise inside as well as improve air quality.
 seat: standard configuration, adjustable.
 Air conditioner: with heating and cooling function
 AM/FM radio: standard configuration with clock.
 Powder fire extinguisher: standard configuration with a capacity of 1kg.

Control Operation

Joystick and traveling pedal are in the front lower part of manipulator position. The left traveling pedal (joystick) drives left crawler belt and the right traveling pedal (joystick) drives right one. Foot accelerator is at the right side of right traveling pedal.
 The control handles of main and auxiliary winch are mounted on the right armrest box, so are the start switch of engine, slow speed control knob and hydraulic pressure servo pressure gauge.
 Luffing auxiliary control handle, revolution control handle, lighter and control panel of air-conditioner are on the left armrest box.
 Hand throttle joystick and revolution locking press button are on the left side of left armrest box.
 Switch panel of auxiliary control box is in the left front of manipulator, through which the corresponding functions can be achieved manually. Screen of load moment indicator and digital monitoring meter are beside the auxiliary control box to display relevant real-time information.

Alarm Display

When error appears, all warning information, including wind speed, water temperature, oil temperature, oil mass, oil pressure, working hours and engine speed, will show on the display screen inside driver's cab.

Lowerworks

Traveling driving

Independent traveling gear is provided in each track frame. The hydraulic traveling motor drives planet gear reducer and achieves independent traveling through driving wheel transmission.

Traveling Brake

The normal state of the band type brake is closed (i.e. it's in braking status when the control pedal valve is not stepped). It is built in reductor and compensated automatically without regulation. When the operating pedal is stepped down, the brake is released and the crane travels.

Track Shoe

The left and right track traveling device consists of 124 track shoes, width of which is 950mm. Tension of track shoe can be adjusted through hydraulic jack. The perfect tensity can be achieved through adjustment of gasket position.

Base

The pin connected to the track frame is pushed with the hydraulic cylinder, and easy to assemble and disassemble. The base is high strength welded frame structure.

Traveling Speed

The variable displacement motor can realize double speed traveling with low speed of 0.68km/h and high speed of 1.0km/h.

Operation device

Main Boom

The high-strength steel main chord pipe is imported from Germany. The boom frame is a space truss type structure welded by steel tube with constant section in the central part and variable cross section on both ends. The tip and butt of boom frame are strengthened with steel plate for easy transmission of load.
 Standard configuration of booms: boom base 7.5m, boom tip 10.5m, boom insert 3m × 2, boom insert 6m × 2, boom insert 9m × 3 and boom insert 9m × 1.
 Length of boom is between the length of basic boom (18m) and maximum length (72m).

Jib

High strength main chord pipe imported from Germany. The arm support is a space truss structure with uniform cross section in the middle and variable cross section at 2 ends. It is welded with steel pipes, and is enforced by steel plates at tip and butt so as to improve the performance of load transmission.
 The basic jib length is 10m (both jib tip and jib base are 5m), and the jib inserts of 6m × 2 and 3m × 1 can be mounted on booms with following length: 39m, 42m, 45m, 48m, 51m, 54m, 57m, 60m and 63m. Available jib lengths are 13m, 19m and 25m.

Hook block

Standard configuration	Optional parts
9t hook block	15t hook block
50t hook block	35t hook block
100t hook block	

Safety Device

Load Moment Indicator

Standard Configuration, optional Manufacturers. There is an independent security operating system controlled by computer on the load moment indicator. It can automatically detect the mass hoisted by the crane and the angle of the boom and indicate the rated load, actual load, operating radius and angle of the boom.
 Component: Monitor, Host Machine Case, Angle Sensor, Force Sensor.
 Function: when the actual load is below 90% of rated load, the NORMAL lamp on display will be on; when the actual load reaches 90% of rated load, the 90% lamp on display will be on and the buzzer on load moment indicator will start to warn at interval; when the actual load reaches 100% of rated load, the 100% lamp will be on and the buzzer will warn at less interval; when the actual load reaches 105% of rated load, the 105% lamp will be on and the buzzer will warn continuously, then the relay acts and the operation of lifting and augmentation of boom working radius will stop automatically.

Anti-overwinding Device for Main and Auxiliary Hooks

Limit switch is used to prevent the hook from being lifted overhigh. When the hook is lifted to a certain height, the limit switch is activated so as to make the buzzer on the auxiliary control board alarming signal by both of power and hydraulic control and make lifting operation of the hook stop automatically. At this time, no operation other than lowering of the hook is operable, so that the overwinding of the hook is prevented.

Boom Limiting Device

When elevation angle of boom is over 78°, the microswitch at the foot of the boom will act to make buzzer alarm and boom in stop status through electrical and hydraulic control. On this occasion, the hoisting operation of luffing winch drum does not work. But the lowering operating does. When the lowering angle of the boom is less than 30°, the operation will be limited. This function is controlled by the load moment indicator automatically.

Anti-tip-back Device for Booms

Anti-tilting bar is mounted at the boom base and consists of 2 steel tubes with the spring at the foot.

Swing Lock

The hydraulic-controlled pin can lock the crane at 4 positions in the fore-and-aft direction and the left-and-right direction.

Winch Drum Lock

The winch drums of main hoisting winch, auxiliary hoisting winch and the luffing winch are equipped with ratchet locking device controlled by the hydraulic cylinder. When the luffing joystick of auxiliary winch and the luffing winch is operated, the hydraulic cylinder will unlock the ratchet of the luffing winch drum. The ratchet of the main winch drum can only be unlocked by pressing down the rocker switch on the auxiliary controlling box.

Boom Angle Indicator

Pendulum-type angle indicator mounted at one side of the boom base.

Hook Clamp

Each kind of hoisting hook is equipped with baffle used to prevent the wire rope from coming off.

Swing Warning Device

Mounted on the counterweight and flashing for warning.

Control Disarming

If the control disarming button is pressed down, all the joysticks will be disarmed so as to avoid any misoperation caused by human body in the course of getting on or off the crane.

Electronic Monitor

It is able to indicate the water temperature, amount of fuel, accumulated service hours, current time, pressure of engine oil, engine speed, charging situation and voltage of battery. It is also equipped with the functions such as warning for the main winch overwinding, auxiliary winch overwinding, warning at the main boom stop by lightening the lamp and belling buzzer.

Rearview Mirror

Mounted in the front of the driver's cab.



SCC1000 Hydraulic Crawler Crane



Dimension

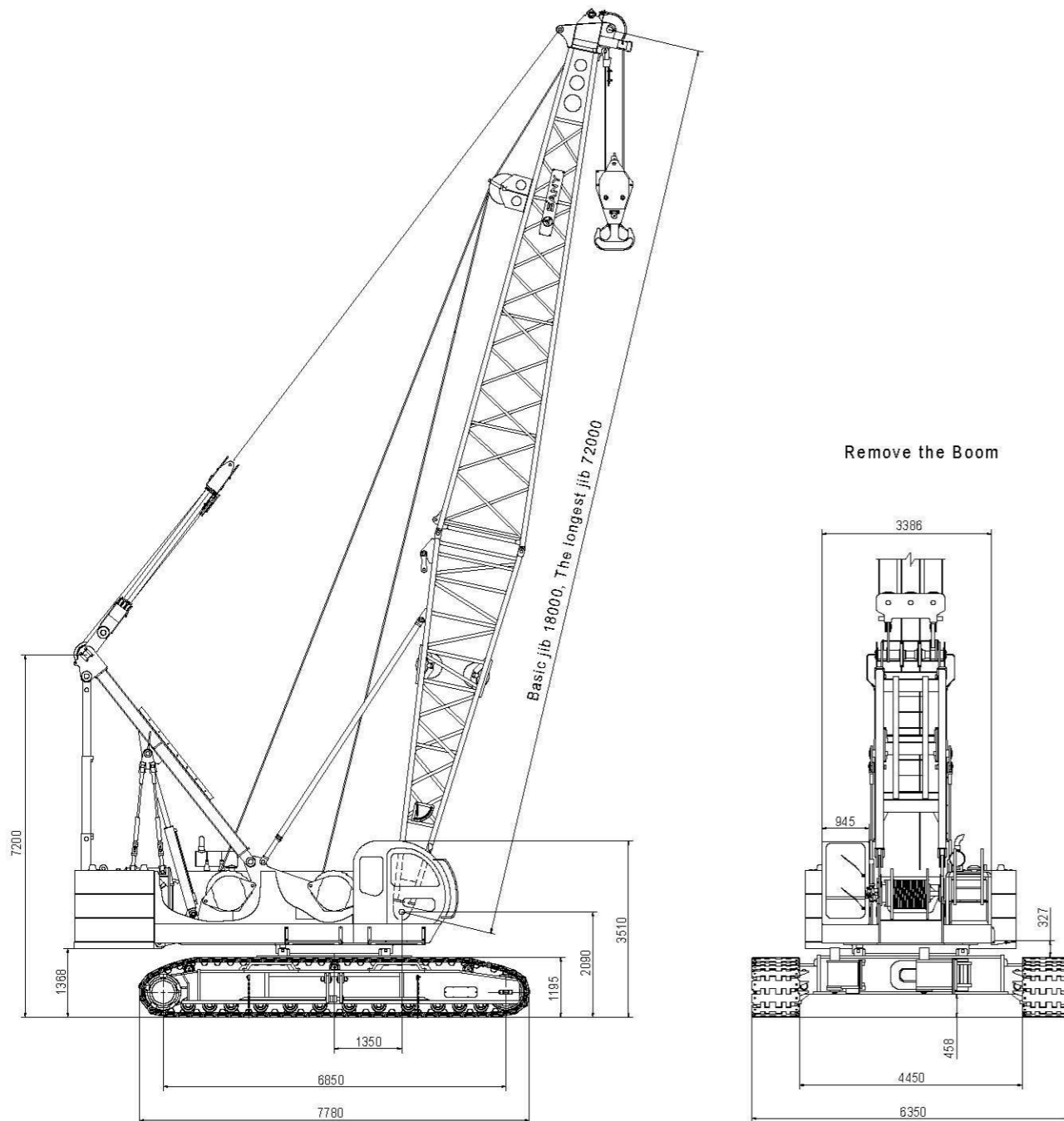

Transportation Dimension of Main Parts

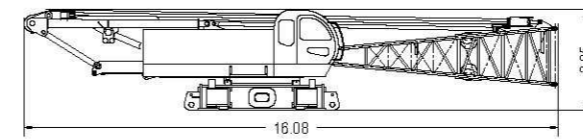

Main body	x 1
Length	16.08 m
Width	3.40 m
Height	3.05 m
Weight	36500 kg

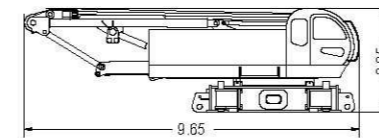

Main body	x 1
Length	9.65 m
Width	3.40 m
Height	3.05 m
Weight	34000 kg

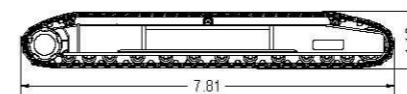

Track assembly	x2
Length	7.81 m
Width	0.95 m
Height	1.19 m
Weight	15600 kg

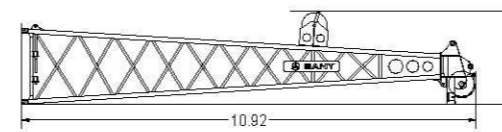

Boom tip	x1
Length	10.92 m
Width	1.81 m
Height	2.24 m
Weight	2030 kg

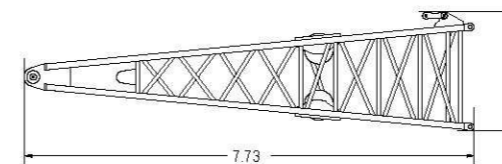

Boom base	x1
Length	7.73 m
Width	1.81 m
Height	2.03 m
Weight	2470 kg

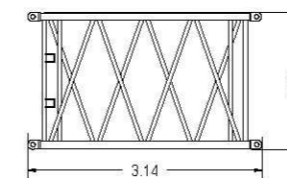

Boom insert 3m	x2
Length	3.14 m
Width	1.81 m
Height	1.83 m
Weight	467 kg

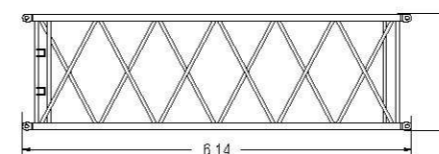

Boom insert 6m	x2
Length	6.14 m
Width	1.81 m
Height	1.83 m
Weight	717 kg



SCC1000 Hydraulic Crawler Crane



Transportation Dimension of Main Parts

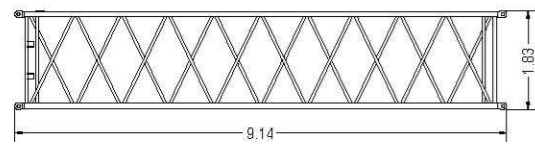

Boom insert 9mA	x3
Length	9.14 m
Width	1.81 m
Height	1.83 m
Weight	1030 kg

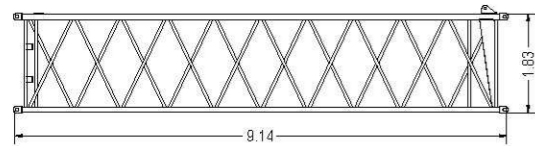

Boom insert 9mB	x1
Length	9.14 m
Width	1.81 m
Height	1.83 m
Weight	1082 kg

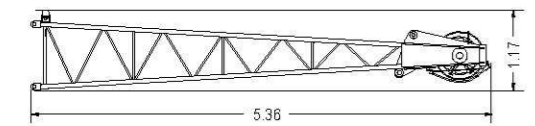

Jib tip	x1
Length	5.36 m
Width	1.01 m
Height	1.17 m
Weight	285 kg

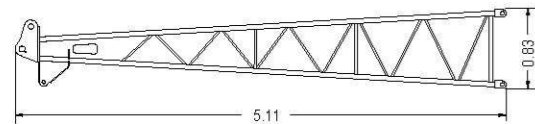

Jib base	x1
Length	5.11 m
Width	1.03 m
Height	0.83 m
Weight	251 kg

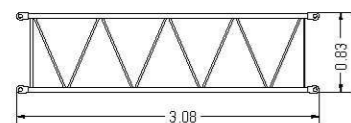

Jib insert 3m	x1
Length	3.08 m
Width	1.01 m
Height	0.83 m
Weight	113 kg

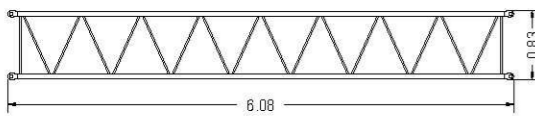

Jib insert 6m	x2
Length	6.08 m
Width	1.01 m
Height	0.83 m
Weight	240 kg

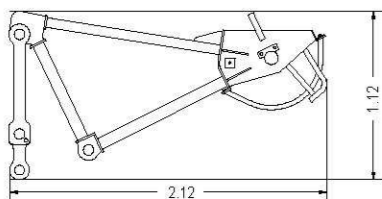

Extension boom	x1
Length	2.12 m
Width	1.04 m
Height	1.12 m
Weight	311 kg

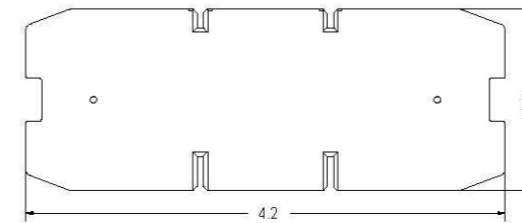

Base counterweight	x1
Length	4.20 m
Width	0.12 m
Height	1.60 m
Weight	6066 kg



Left counterweight	x3
Length	1.60 m
Width	1.19 m
Height	0.55 m
Weight	5981 kg



Right counterweight	x3
Length	1.60 m
Width	1.19 m
Height	0.55 m
Weight	5981 kg

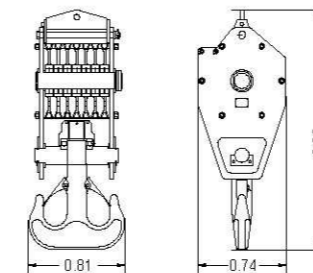

100t hook block	x1
Length	0.81 m
Width	0.74 m
Height	2.03 m
Weight	1580 kg

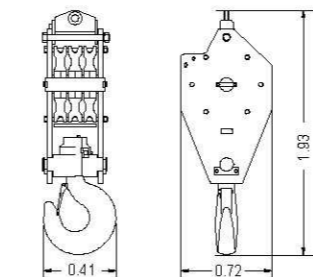

50t hook block	x1
Length	0.72 m
Width	0.41 m
Height	1.83 m
Weight	685 kg



SCC1000 Hydraulic Crawler Crane



Transportation Dimension of Main Parts

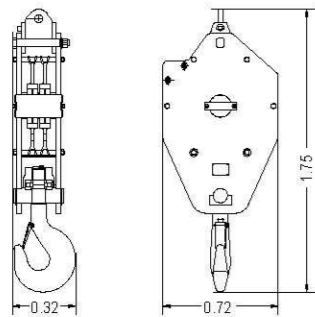

35t hook block	x1
Length	0.72 m
Width	0.32 m
Height	1.75 m
Weight	599 kg

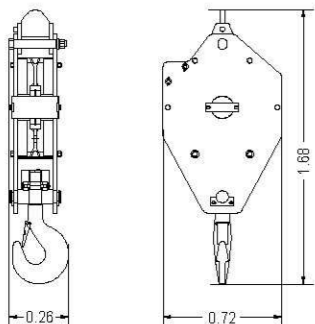

15t hook block	x1
Length	0.72 m
Width	0.26 m
Height	1.68 m
Weight	489 kg

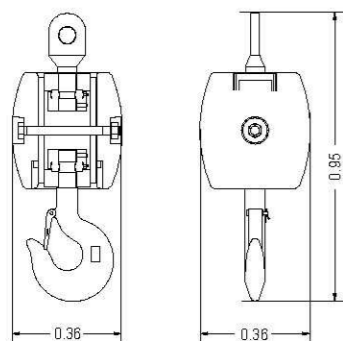

9t hook block	x1
Length	0.36 m
Width	0.36 m
Height	0.95 m
Weight	246 kg

Self and jib assembly and disassembly

This crane is equipped with functions including the self-assembly and disassembly of track traveling mechanism and self-assembly and disassembly of the counterweight. In the course of assembly, the track traveling mechanism should be assembled firstly and then the counterweight. In the course of disassembly, the counterweight should be disassembled firstly and then the track traveling mechanism. See the figure below for detailed operation procedures.

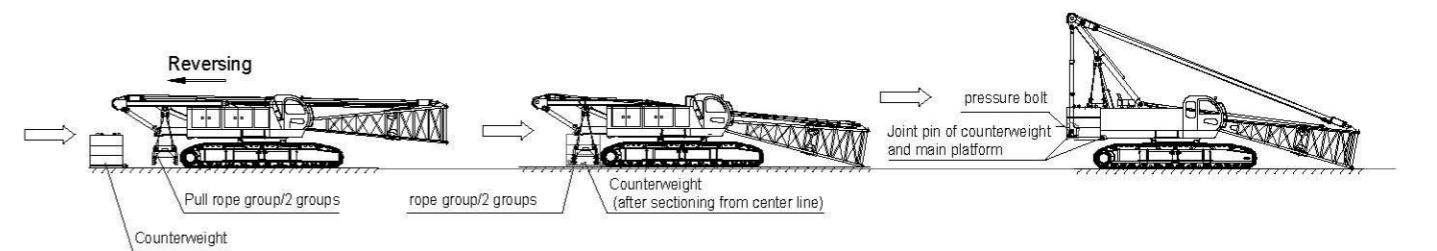
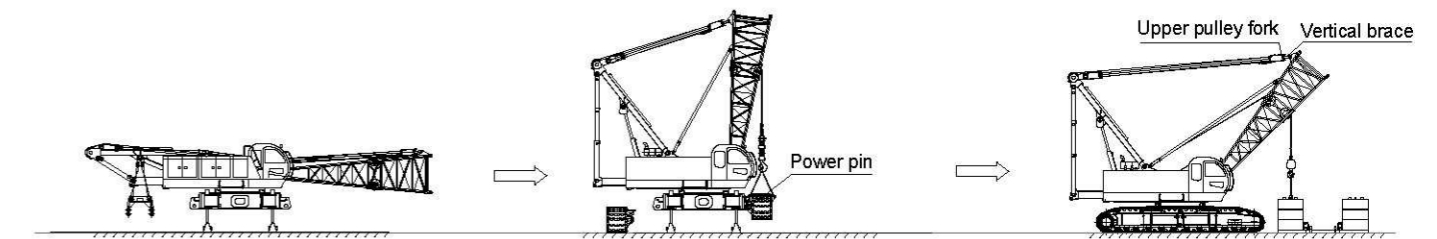

Schematic diagram of self assembly of track frame and counterweight (perform reverse procedure for disassembly)

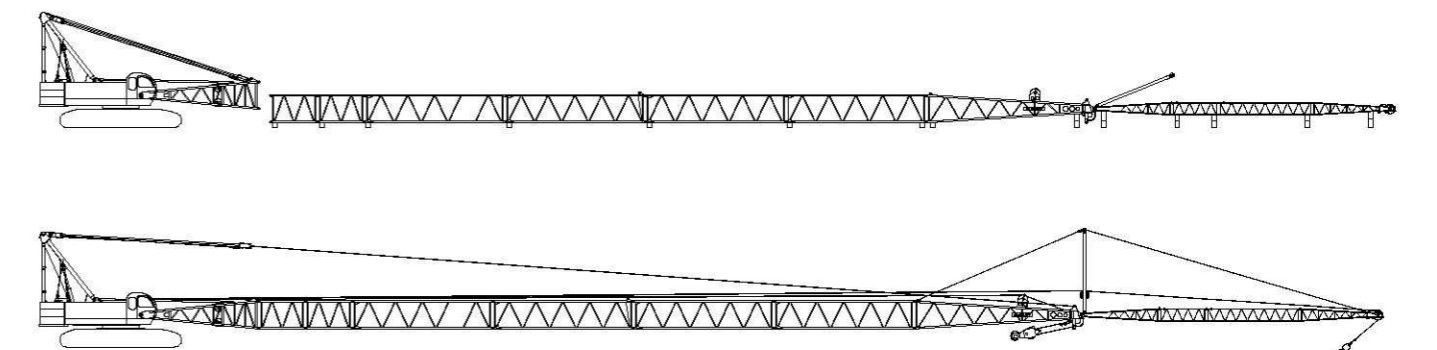

Schematic diagram of jib assembly



SCC1000 Hydraulic Crawler Crane



Main Boom Combination

Boom length (m)	Main boom insert			
	3m	6m	9mA	9mB
18	-	-	-	-
21	1	-	-	-
24	-	1	-	-
	2	-	-	-
27	1	1	-	-
	-	-	1	-
30	1	-	1	-
	-	2	-	-
33	1	2	-	-
	-	1	1	-
36	1	1	1	-
	-	-	2	-
39	2	2	-	-
	1	1	-	-
42	1	-	2	-
	-	2	1	-
45	2	-	2	-
	-	1	2	-
48	1	1	2	-
	-	-	3	-
51	2	2	1	-
	1	-	3	-
54	2	1	2	-
	-	2	2	-
57	-	1	3	-
	2	-	3	-
60	2	2	2	-
	1	1	3	-
63	2	1	3	-
	-	2	3	-
66	1	2	2	1
	2	-	3	1
69	2	2	2	1
	2	1	3	1
72	1	2	3	1
	2	2	3	1

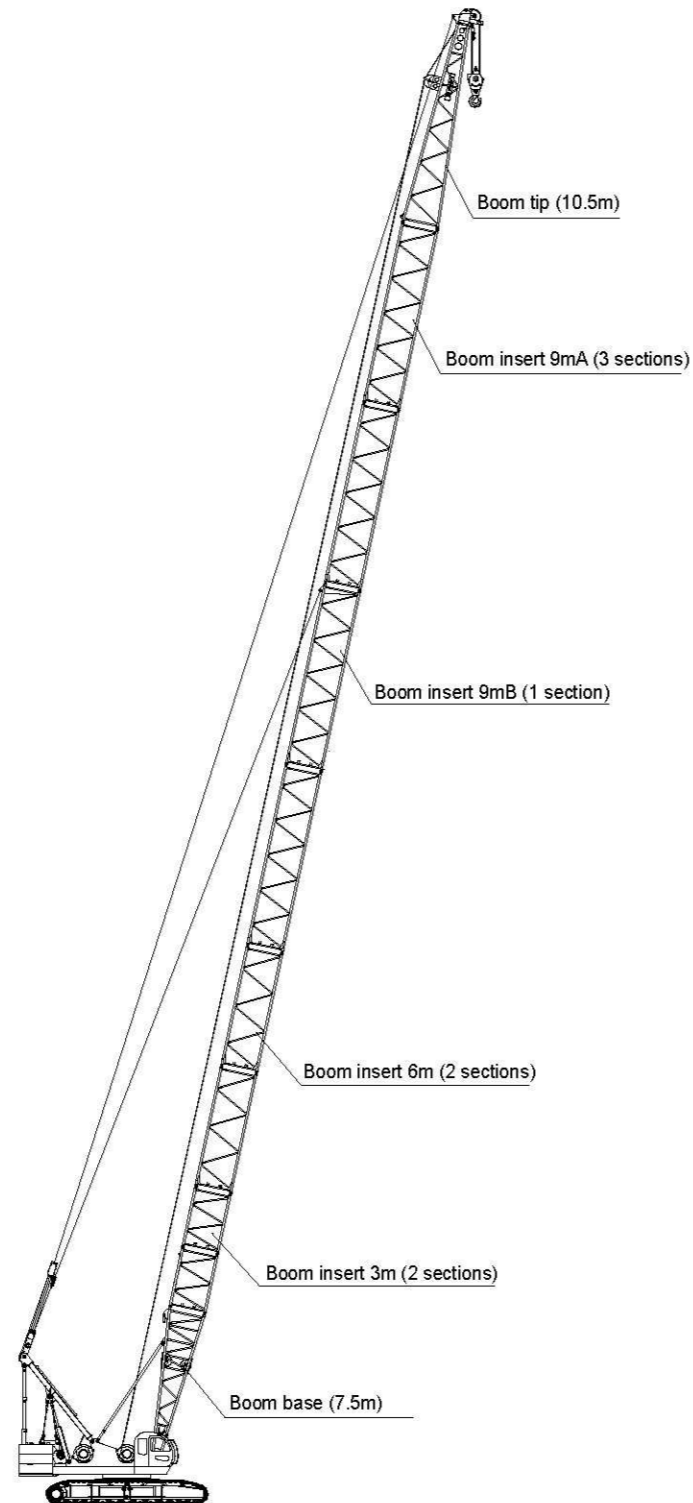

Main boom section combination (18m-72m)

Main Boom Range Diagram

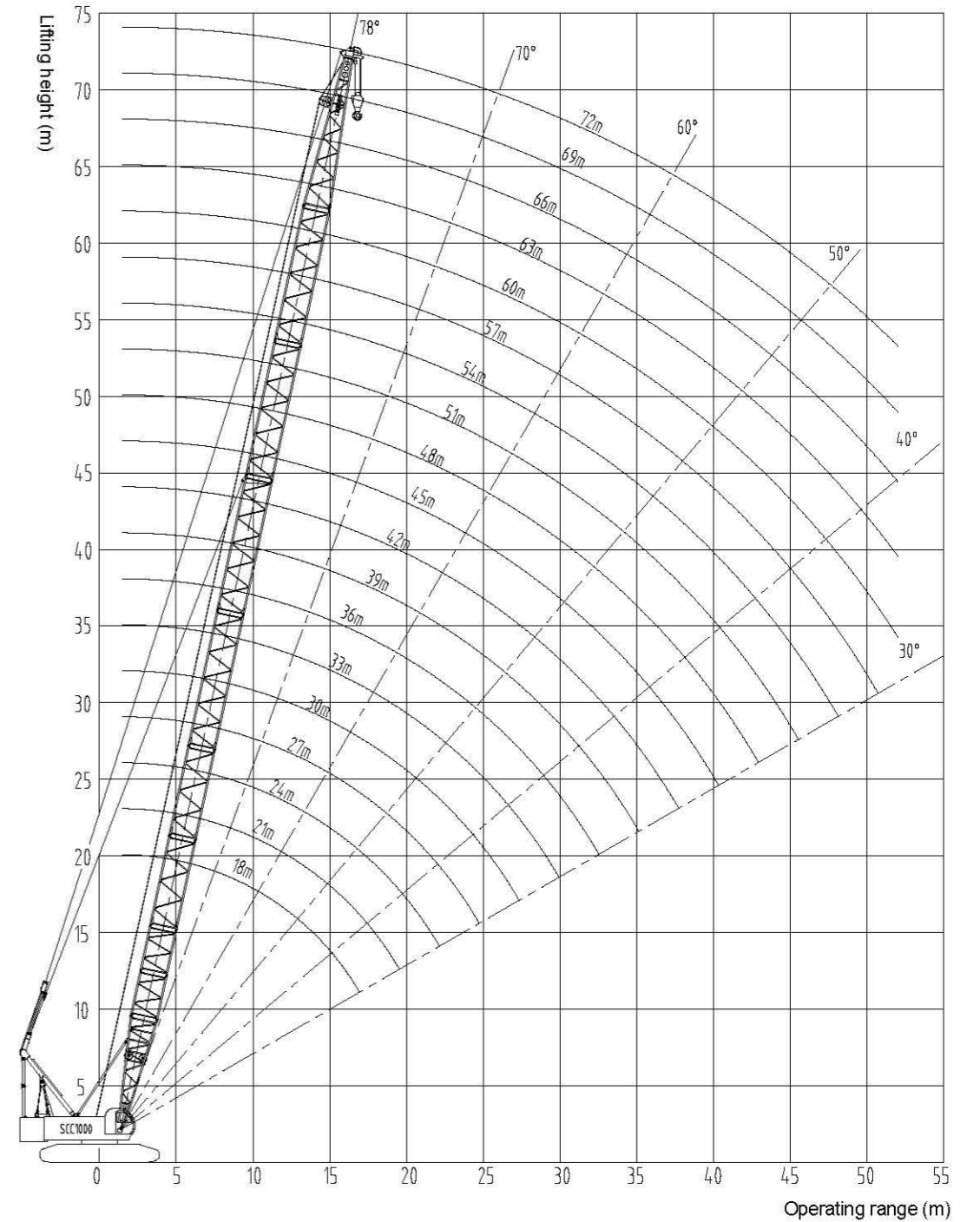

Curve of lifting height scope



SCC1000 Hydraulic Crawler Crane



Main Boom Load Chart

unit: t

Job Radius (m)	Main Boom Length																		
	18	21	24	27	30	33	36	39	42	45	48	51	54	57	60	63	66	69	72
5.1	105.0																		
5.5	100.0	5.6/90.9																	
6.0	92.5	90.0	6.1/80.8	6.6/70.8															
7.0	79.5	78.7	77.5	70.0	7.2/60.5	7.7/57.3													
8.0	66.0	65.7	65.5	64.6	60.0	56.6	8.2/50.5	8.7/46.6											
9.0	55.2	55.1	54.9	54.8	54.7	54.2	50.0	46.2	9.3/44.2	9.8/41.2									
10.0	47.5	47.3	47.2	47.1	46.9	46.8	46.6	44.7	42.4	40.4	10.3/35.6	10.9/32.8	11.4/28.7	11.9/26.3					
12.0	36.9	36.7	36.5	36.4	36.3	36.1	36.0	35.9	35.8	35.7	33.7	30.3	28.2	26.2	12.4/24.5	13.0/22.9	13.5/19.4		
14.0	30.1	29.8	29.6	29.5	29.3	30.2	29.1	28.9	28.8	28.7	28.6	28.5	26.9	25.3	23.7	21.8	19.2	14.1/17.8	14.6/16.0
16.0	25.2	25.0	24.8	24.7	24.5	24.3	24.2	24.0	23.9	23.8	23.7	23.5	23.4	23.2	22.1	20.2	18.3	17.0	15.4
18.0	17.5/21.7	21.5	21.2	21.1	20.9	20.8	20.7	20.5	20.4	20.2	20.1	20.0	19.8	19.6	19.5	19.4	17.5	16.2	14.6
20.0		19.4	18.6	18.4	18.2	18.0	17.9	17.7	17.6	17.5	17.4	17.2	17.1	16.9	16.8	16.7	16.5	15.5	13.9
22.0		21.1/17.1	17.0	16.3	16.1	15.9	15.8	15.6	15.5	15.3	15.2	14.9	14.8	14.6	14.5	14.4	14.2	14.0	13.0
24.0			22.7/14.7	14.5	14.2	14.1	14.0	13.7	13.6	13.5	13.3	13.2	13.0	12.8	12.7	12.6	12.4	12.2	12.0
26.0				25.4/12.8	12.7	12.6	12.5	12.3	12.2	12.0	11.9	11.7	11.5	11.3	11.2	11.1	10.9	10.7	10.5
28.0					28.0/11.1	11.4	11.3	11.0	10.9	10.8	10.6	10.5	10.3	10.1	10.0	9.9	9.7	9.5	9.3
30.0						10.5	10.3	10.0	9.9	9.7	9.6	9.4	9.3	9.0	8.9	8.8	8.6	8.4	8.2
32.0							30.7/9.7	9.4	9.1	9.0	8.8	8.7	8.5	8.4	8.1	8.0	7.9	7.7	7.3
34.0								33.3/8.6	8.4	8.2	8.1	7.9	7.7	7.6	7.3	7.2	7.1	6.9	6.5
36.0									35.9/7.4	7.3	7.2	7.1	7.0	6.9	6.6	6.5	6.4	6.2	5.8
38.0										6.8	6.7	6.5	6.4	6.3	6.0	6.0	5.8	5.6	5.1
40.0											38.6/6.5	6.2	6.1	5.9	5.7	5.5	5.4	4.9	4.3
42.0												41.2/5.6	5.5	5.4	5.2	4.9	4.8	4.3	3.8
44.0													43.9/4.7	4.6	4.5	4.4	4.3	4.1	3.2
46.0														4.4	4.3	4.0	3.8	3.3	2.8
48.0															46.5/3.9	3.6	3.5	3.2	2.3
50.0																49.1/3.3	3.1	3.0	2.0
52.0																	51.8/2.7	2.6	1.8

Note: 1. The actual hoisting duty is the value that rated hoisting duty in the table deducts the weight of hook block and other lifting tools.
 2. Rated hoisting duty in this table is the weight lifted from level and hard ground.

Jib Range Diagram

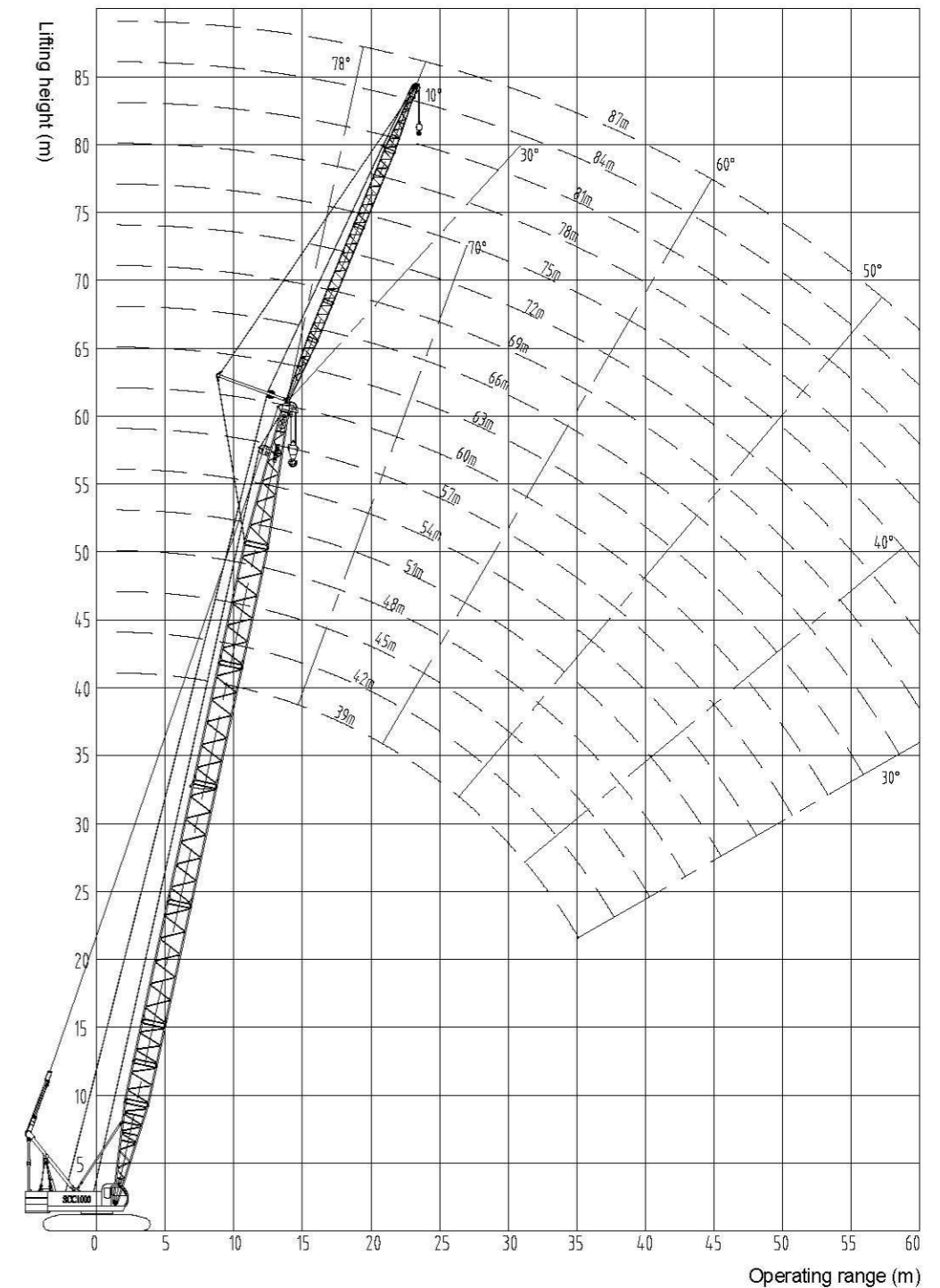



SCC1000 Hydraulic Crawler Crane



Jib Combination

Length of Jib (m)	Intermediate Section of Main Boom		Length of Main Boom (m)	Included Angle between Main Boom and Jib
	3m	6m		
13	1	-	39~63	15°, 30°
19	1	1	39~63	15°, 30°
25	1	2	39~60	15°, 30°

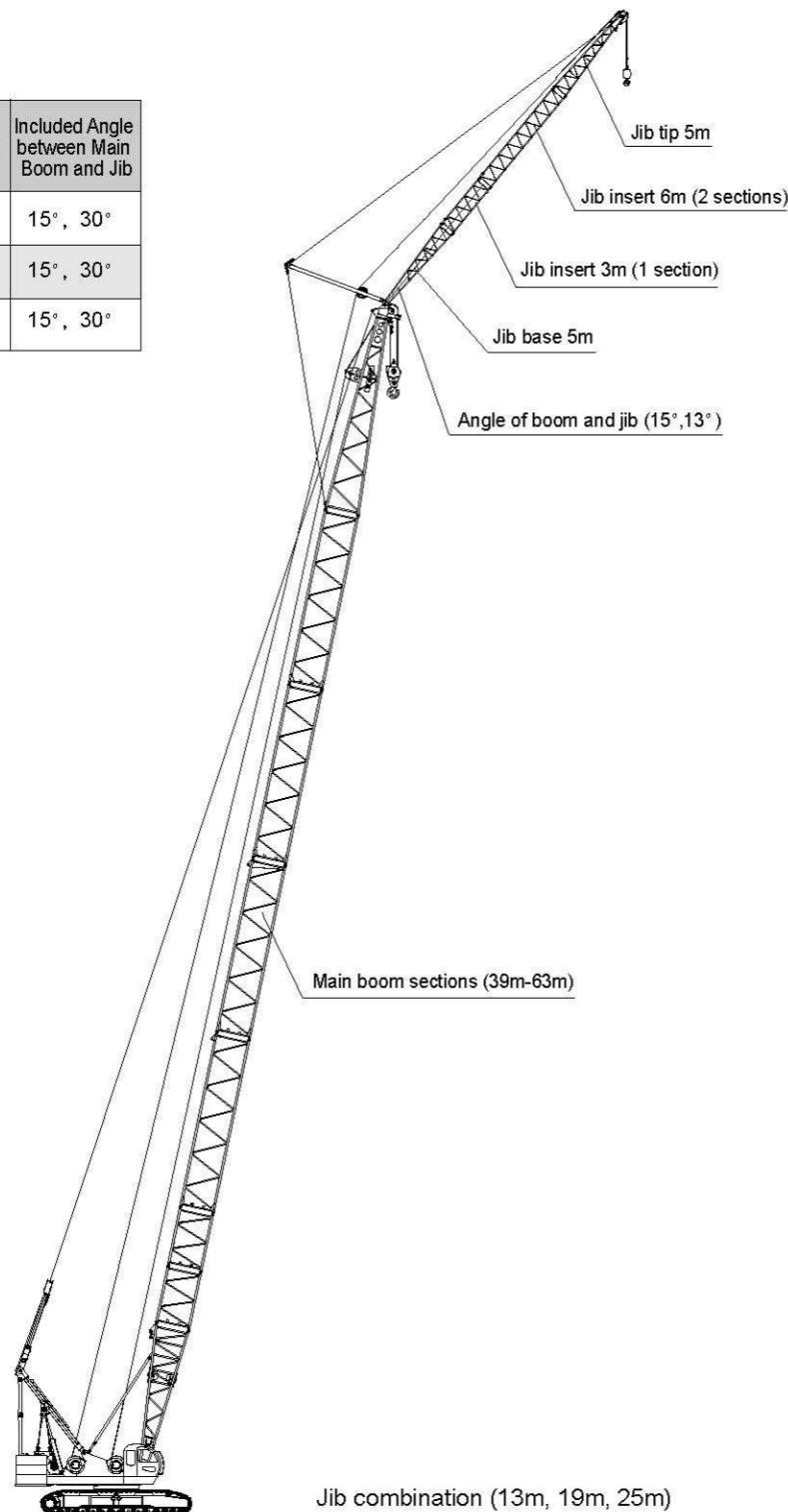

Jib combination (13m, 19m, 25m)

Jib Load Chart

Basic Boom:39m

Jib Length	13m		19m		25m	
Angle of Jib	15°	30°	15°	30°	15°	30°
Radius						
14m	14.3/11.0					
16m	11	17.2/8.0	17.2/7.2			
18m	11	8	7.2		19.5/4.6	
20m	11	8	7.2	21.1/5.7	4.6	
22m	11	8	7.2	5.7	4.6	
24m	11	8	7.2	5.7	4.6	25.1/3.9
26m	11	8	7.2	5.7	4.6	3.9
28m	29.0/11.0	8	7.2	5.7	4.6	3.9
30m	10.6	8	7.2	5.7	4.6	3.9
32m	10	8	7.2	5.7	4.6	3.9
34m	9.4	8	7.2	5.7	4.6	3.9
36m	34.7/9.4	34.7/8.0	34.7/7.2	34.7/5.7	34.7/4.6	34.7/3.9
38m						
40m						

Basic boom:39m

Jib length	13m		19m		25m	
Angle of Jib	15°	30°	15°	30°	15°	30°
Radius						
14m	15.1/11.0					
16m	11					
18m	11	18.2/8.0	18.1/7.2			
20m	11	8	7.2		20.7/4.6	
22m	11	8	7.2	22.3/5.7	4.6	
24m	11	8	7.2	5.7	4.6	25.9/3.9
26m	11	8	7.2	5.7	4.6	3.9
28m	11	8	7.2	5.7	4.6	3.9
30m	30.3/11.0	8	7.2	5.7	4.6	3.9
32m	10.2	8	7.2	5.7	4.6	3.9
34m	9.2	8	7.2	5.7	4.6	3.9
36m	8.4	36.8/8.0	7.2	5.7	4.6	3.9
38m	8.1	7.8	7.2	5.7	4.6	3.9
40m	7.5	7.4	7.2	5.7	4.6	3.9
42m	40.3/7.4	40.3/7.3	40.3/7.2	40.3/5.7	40.3/4.6	40.3/3.9
44m						
46m						

Basic boom:42m

Jib Length	13m		19m		25m	
Angle of Jib	15°	30°	15°	30°	15°	30°
Radius						
14m	14.9/11.0					
16m	11		17.6/7.2			
18m	11	18.2/8.0	7.2			
20m	11	8	7.2	21.5/5.7	20.1/4.6	
22m	11	8	7.2	5.7	4.6	
24m	11	8	7.2	5.7	4.6	25.4/3.9
26m	11	8	7.2	5.7	4.6	3.9
28m	11	8	7.2	5.7	4.6	3.9
30m	11	8	7.2	5.7	4.6	3.9
32m	10.3	8	7.2	5.7	4.6	3.9
34m	9.3	8	7.2	5.7	4.6	3.9
36m	8.4	8	7.2	5.7	4.6	3.9
38m	37.1/8.2	37.1/8.0	37.1/7.2	37.1/5.7	37.1/4.6	37.1/3.9
40m						

Basic boom:48m

Jib length	13m		19m		25m	
Angle of Jib	15°	30°	15°	30°	15°	30°
Radius						
14m						
16m	15.9/11.0					
18m	11	18.4/8.0	18.2/7.2			
20m	11	8	7.2		21.2/4.6	
22m	11	8	7.2	22.7/5.7	4.6	
24m	11	8	7.2	5.7	4.6	
26m	11	8	7.2	5.7	4.6	26.5/3.9
28m	11	8	7.2	5.7	4.6	3.9
30m	30.1/11.0	8	7.2	5.7	4.6	3.9
32m	10.1	8	7.2	5.7	4.6	3.9
34m	9.1	8	7.2	5.7	4.6	3.9
36m	8.2	8	7.2	5.7	4.6	3.9
38m	8	7.4	7.2	5.7	4.6	3.9
40m	7.3	7.3	7.2	5.7	4.6	3.9
42m	7.1	7.1	7	5.7	4.6	3.9
44m	42.8/6.9	42.8/6.8	42.8/6.7	42.8/5.7	42.8/4.6	42.8/3.9
46m						



SCC1000 Hydraulic Crawler Crane



Basic boom:51m

Jib Length	13m		19m		25m	
	15°	30°	15°	30°	15°	30°
Radius						
16m	16.3/11.0					
18m	11	19.1/8.0	18.7/7.2			
20m	11	8	7.2			
22m	11	8	7.2	23.4/5.7	21.9/4.6	21.5/3.9
24m	11	8	7.2	5.7	4.6	3.9
26m	11	8	7.2	5.7	4.6	3.9
28m	11	8	7.2	5.7	4.6	3.9
30m	9.6/11.0	8	7.2	5.7	4.6	3.9
32m	9.9	8	7.2	5.7	4.6	3.9
34m	9	8	7.2	5.7	4.6	3.9
36m	8.1	36.2/8.0	7.2	5.7	4.6	3.9
38m	8	7.3	7.2	5.7	4.6	3.9
40m	7.2	7.1	40.9/7.2	5.7	4.6	3.9
42m	6.9	6.9	6.8	5.7	4.6	3.9
44m	6.7	6.7	6.6	5.7	4.6	3.9
46m	44.6/6.2	44.6/6.2	44.6/6.1	44.6/5.7	44.6/4.6	44.6/3.9

Basic boom:54m

Jib Length	13m		19m		25m	
	15°	30°	15°	30°	15°	30°
Radius						
16m	17.1/11.0					
18m	11					
20m	11	20.1/8.0	20.0/7.2			
22m	11	8	7.2		22.3/4.6	
24m	11	8	7.2	25.2/5.7	4.6	
26m	11	8	7.2	5.7	4.6	
28m	11	8	7.2	5.7	4.6	28.1/3.9
30m	11	8	7.2	5.7	4.6	3.9
32m	9.8	8	7.2	5.7	4.6	3.9
34m	8.9	8	7.2	5.7	4.6	3.9
36m	8.1	8	7.2	5.7	4.6	3.9
38m	8	7.2	37.8/7.2	5.7	4.6	3.9
40m	7.1	7	7	5.7	4.6	3.9
42m	6.7	6.6	6.5	5.7	4.6	3.9
44m	6.6	6.5	6.4	5.7	4.6	3.9
46m	6.1	6.1	6.1	5.7	4.6	3.9
48m	5.8	5.8	5.7	5.7	4.6	3.9
50m	48.1/5.7	48.1/5.7	48.1/5.7	48.1/5.7	48.1/4.6	48.1/3.9

Basic boom:57m

Jib Length	13m		19m		25m	
	15°	30°	15°	30°	15°	30°
Radius						
14m						
16m						
18m	18.3/11					
20m	11	20.6/8.0	20.4/7.2			
22m	11	8	7.2		23.1/4.6	
24m	11	8	7.2	24.6/5.7	4.6	
26m	11	8	7.2	5.7	4.6	
28m	29.3/11.0	8	7.2	5.7	4.6	28.2/3.9
30m	9.7	8	7.2	5.7	4.6	3.9
32m	9.5	8	7.2	5.7	4.6	3.9
34m	8.7	8	7.2	5.7	4.6	3.9
36m	8	37.1/8.0	7.2	5.7	4.6	3.9
38m	7.8	7.2	38.7/7.2	5.7	4.6	3.9
40m	7	6.8	7	5.7	4.6	3.9
42m	6.5	6.4	6.2	5.7	4.6	3.9
44m	6.4	6.3	6.1	5.7	4.6	3.9
46m	6	6	6	47.1/5.7	4.6	3.9
48m	5.7	5.7	5.6	5.5	4.6	3.9
50m	5.5	5.4	5.3	5.2	4.6	3.9
52m	50.5/5.1	50.5/5.0	50.5/4.9	50.5/4.8	50.5/4.6	50.5/3.9
54m						

Basic boom:60m

Jib Length	13m		19m		25m	
	15°	30°	15°	30°	15°	30°
Radius						
14m						
16m						
18m	18.2/11.0					
20m	11	21.2/8.0	21.0/7.2			
22m	11	8	7.2		23.5/4.6	
24m	11	8	7.2	24.4/5.7	4.6	
26m	11	8	7.2	5.7	4.6	
28m	29.7/11.0	8	7.2	5.7	4.6	29.1/3.9
30m	9.6	8	7.2	5.7	4.6	3.9
32m	9.4	8	7.2	5.7	4.6	3.9
34m	8.5	8	7.2	5.7	4.6	3.9
36m	8	36.3/8.0	7.2	5.7	4.6	3.9
38m	7.6	7.2	38.2/7.2	5.7	4.6	3.9
40m	6.9	6.7	6.6	5.7	4.6	3.9
42m	6.4	6.3	6.2	5.7	4.6	3.9
44m	6.2	6.1	6	5.7	4.6	3.9
46m	5.8	5.7	5.7	46.8/5.7	4.6	3.9
48m	5.5	5.4	5.3	5.2	4.6	3.9
50m	5.4	5.2	5.1	5	4.6	3.9
52m	5	4.9	4.8	4.6	4.6	3.9
54m	52.8/4.4	52.8/4.3	52.8/4.3	52.8/4.3	52.8/4.2	52.8/3.9
56m						

Basic boom:63m

Jib Length	13m		19m			
	15°	30°	15°	30°		
Radius						
14m						
16m						
18m	18.7/11.0					
20m	11		21.3/7.2			
22m	11	8	7.2			
24m	11	8	7.2	24.2/5.7		
26m	11	8	7.2	5.7		
28m	29.9/11.0	8	7.2	5.7		
30m	9.4	8	7.2	5.7		
32m	9.1	8	7.2	5.7		
34m	8.2	35.1/8.0	7.2	5.7		
36m	7.8	7.7	7.2	5.7		
38m	7.4	7.2	7.2	5.7		
40m	6.7	6.5	6.4	5.7		
42m	6.2	6.1	6.1	5.7		
44m	6	5.7	5.7	45.3/5.7		
46m	5.6	5.5	5.4	5.2		
48m	5.3	5.1	5	4.9		
50m	5.2	5	4.9	4.7		
52m	5	4.7	4.7	4.6		
54m	4.3	4.1	4.1	4		
56m	55.7/3.8	55.7/3.7	55.7/3.6	55.7/3.5		